

*FEHLING...*

*... THE DIFFERENCE*

10

BRAIN INSTRUMENTS  
HIRNCHIRURGISCHE  
INSTRUMENTE



**FEHLING**  
INSTRUMENTS

Hanauer Landstr. 7A · 63791 Karlstein/Germany · [www.fehling-instruments.de](http://www.fehling-instruments.de)



+49 (0) 61 88 - 95 74.40



+49 (0) 61 88 - 95 74.45



[info@fehling-instruments.de](mailto:info@fehling-instruments.de)

CERAMO®

CRANIAL SET  
KRANIALES SET



1/2

STRAIGHT  
GERADE

ABB-1



1/2

BAYONET  
BAJONETT

ABB-2

HANDLES  
HANDGRIFFE



1/4

STERILISATION AND STORAGE TRAY  
STERILISATIONS- UND AUFBEWAHRUNGSBOX

210 x 180 mm

NUM-0

210 x 230 mm





NVM-0



1/2











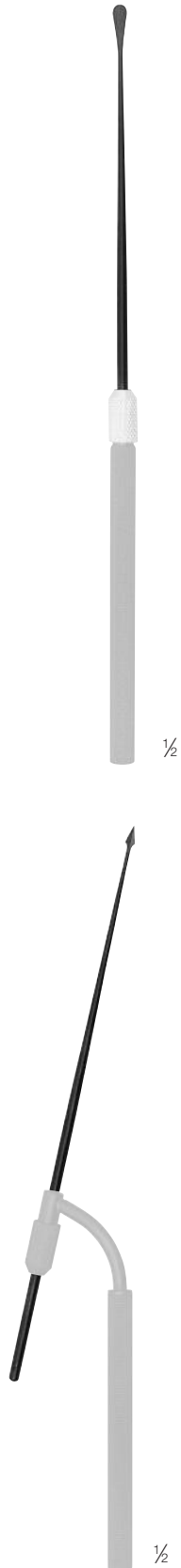



1/2

		160 mm	210 mm
 90° 1/4 ring curette / Ringkürette	2 mm	NUM-1	NVM-1
	4 mm	NUM-2	NVM-2
	6 mm	NUM-3	NVM-3
 45° 1/4 ring curette / Ringkürette	2 mm	NUM-4	NVM-4
	4 mm	NUM-5	NVM-5
	6 mm	NUM-6	NVM-6
 45° 1/4 ring curette / Ringkürette	2 mm	NUM-7	NVM-7
	4 mm	NUM-8	NVM-8
	6 mm	NUM-9	NVM-9
 40° 1/4 ring curette / Ringkürette	2 mm	NUR-1	NVR-1
	4 mm	NUR-2	NVR-2
	6 mm	NUR-3	NVR-3
 60° 1/4 ring curette / Ringkürette	2 mm	NUR-4	NVR-4
	4 mm	NUR-5	NVR-5
	6 mm	NUR-6	NVR-6

CERAMO®

CRANIAL SET  
KRANIALES SET









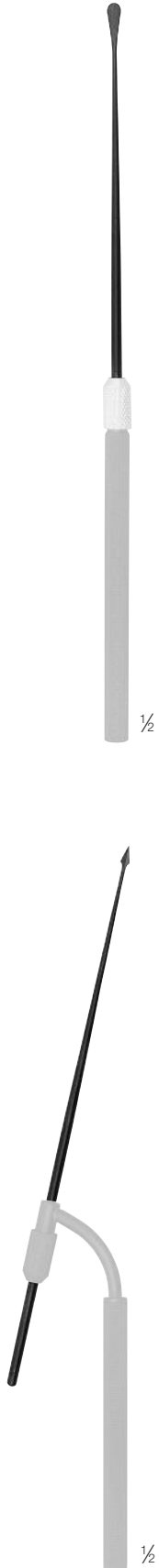











		160 mm	210 mm	
	1 mm	NUN-1	NVN-1	
	$\frac{1}{4}$ dissector / Dissektor sharp / scharf	2 mm	NUN-2	NVN-2
	3 mm	NUN-3	NVN-3	
	1 mm	NUN-4	NVN-4	
	1,5 mm	NUN-9	NVN-9	
	$\frac{1}{4}$ dissector / Dissektor blunt / stumpf	2 mm	NUN-5	NVN-5
	3 mm	NUN-6	NVN-6	
	4 mm	NUN-7	NVN-7	
	$\frac{1}{4}$ dissector / Dissektor blunt / stumpf	4 mm	NUN-8	NVN-8
	2 mm	NUO-1	NVO-1	
	$\frac{1}{4}$ bone curette scharfer Löffel	3 mm	NUO-2	NVO-2
	4 mm	NUO-3	NVO-3	
	2 mm	NUO-4	NVO-4	
	$\frac{1}{4}$ bone curette scharfer Löffel	3 mm	NUO-5	NVO-5
	4 mm	NUO-6	NVO-6	
	1 x 2 mm	NUT-4	NVT-4	
	$\frac{1}{4}$ nerv hook / Nervhaken	1 x 4 mm	NUT-5	NVT-5
	1 x 2 mm	NUP-1	NVP-1	
	1 x 3 mm	NUP-2	NVP-2	
	$\frac{1}{4}$ nerv hook / Nervhaken	1 x 4 mm	NUP-6	NVP-6
	1 x 5 mm	NUP-4	NVP-4	
	1 x 8 mm	NUP-5	NVP-5	
	0,4 x 2 mm	NUP-7	NVP-7	
	$\frac{1}{4}$ nerv hook / Nervhaken semi sharp / halbscharf	0,4 x 3 mm	NUP-8	NVP-8
	1 x 3 mm	NUS-0	NVS-0	
	1 x 3 mm	NUP-9	NVP-9	
	$\frac{1}{4}$ nerv hook / Nervhaken	1 x 5 mm	NUS-1	NVS-1
	1 x 8 mm	NUS-2	NVS-2	
	1 x 5 mm	NUS-3	NVS-3	
	1 x 3 mm	NUS-9	NVS-9	
$\frac{1}{4}$ nerv hook / Nervhaken pointed / spitz				

CERAMO®

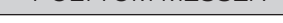
CRANIAL SET  
KRANIALES SET



		160 mm	210 mm
	1/4 needle / Nadel	NUS-8	NVS-8
	1/4 ball probe / Knopfsonde	1 mm NUS-4	NVS-4
	1/4 lancet knife / Lanzettmesser	NUS-6	NVS-6
	1/4 sickle knife / Sichelmesser	NUS-7	NVS-7
	1/4 pulling knife / Zugmesser	3,5 mm NUP-3	NVP-3
	1/4 disc knife / Tellermesser	4 mm NUT-1	NVT-1
	1/4 disc knife / Tellermesser	2 mm NUT-2	NVT-2
	1/4 disc knife / Tellermesser	4 mm NUT-3	NVT-3
	1/4 micro knife / Mikromesser	NUT-6	-
	1/4 disc dissector / Tellerdissektor	2 mm NUT-7	-
	1/4 disc dissector / Tellerdissektor	4 mm NUT-8	-
	1/4 LANKSCH nerve root retractor Nervwurzelhaken	3 mm NUO-7	-
	1/4 LANKSCH nerve root retractor Nervwurzelhaken	5 mm NUO-8	-
	1/4 tamper / Stößel	2 mm NUX-1	-
	1/4 tamper / Stößel	4 mm NUX-2	-
	1/4 tamper / Stößel	6 mm NUX-3	-
POLYTOM KNIVES* POLYTOM MESSER*		160 mm	
	1/4 pulling knife / Zugmesser	4 mm NUL-1	-
	1/4 pushing knife / Schubmesser	4,5 mm NUL-2	-
	1/4 micro knife / Mikromesser	FIGURE 11 FIGUR 11 NUT-9	-

\*EXTRA HARD CARBON SURFACE

\*EXTREM HARTE KOHLENSTOFFOBERFLÄCHE



1/4

CERAMO®  
RHOTON  
190 mm

	1 mm	NTC-1
	2 mm	NTC-2
	3 mm	NTC-3
	1 mm	NTC-6
	1,5 mm	NTC-7
	2 mm	NTC-8
	1,2 mm	NTC-5
	2,8 mm	NTC-4
	2 mm	NTC-9
	2 mm	NTD-1
	3 mm	NTD-2
		NTD-3
	1 x 2 mm	NTD-4
	1 x 2 mm	NTD-5
		NTD-6



1/8

STERILIZATION AND STORAGE TRAY  
STERILISATIONS- UND AUFBEWAHRUNGSBEHÄLTER  
210 X 230 X 20 mm

NBX-4



1/4

NERVE HOOK  
NERVHAKEN  
230 mm

	3 mm	NBP-4
	5 mm	NBP-5
	8 mm	NBP-6
	14 mm	NEW-4

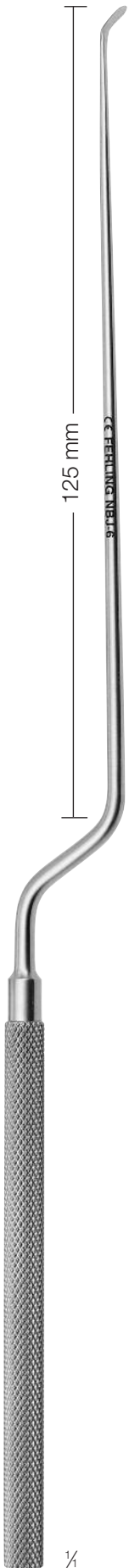

BONE CURETTES  
SCHARFE LÖFFEL

	45° 	90° 	45° 
Ø 3 mm	Ø 3 mm	Ø 3 mm	Ø 3 mm
NBC-3	NBC-4	NBC-5	NBC-6

	45° 	90° 
	Ø 3 mm	Ø 3 mm
UP / AUF	NBC-7	NBD-2
DOWN / AB	NBC-8	NBD-3
RIGHT / RECHTS	NBC-9	NBD-4
LEFT / LINKS	NBD-1	NBD-5

ALL MODELS ALSO  
AVAILABLE WITH  
CERAMO SURFACE

ALLE MODELLE AUCH  
MIT CERAMO-OBER-  
FLÄCHE ERHÄLTICH

RING CURETTES  
RINGKÜRETTEN

45° 	45° 	90° 	90° 
Ø 2,5 mm	Ø 4,0 mm	Ø 2,5 mm	Ø 4,0 mm
NBB-6	NBB-7	NBB-4	NBB-5

DISSECTORS  
DISSEKTOREN

SICKLE KNIFE  
SICHELMESSER

	2 mm	4 mm	3 x 5 mm	1/4
UP / AUF	NAZ-6	NBA-1	NBJ-6	NAY-9
DOWN / AB	NAZ-7	NBA-2	-	NAZ-1
RIGHT / RECHTS	NAZ-8	-	NBK-7	NAY-7
LEFT / LINKS	NAZ-9	-	NBL-2	NAY-8

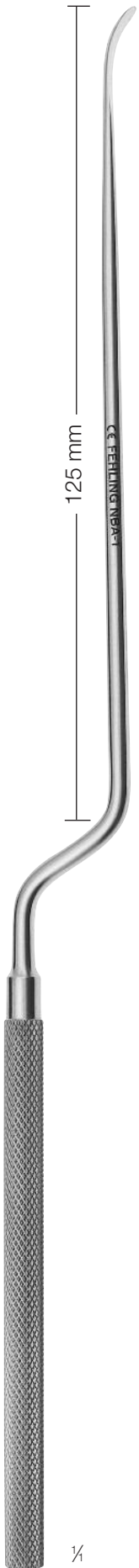

RASPATORIES  
RASPATORIEN

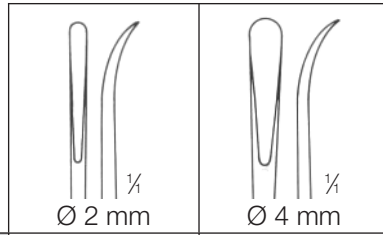

UP / AUF	NBB-8	NBC-1
DOWN / AB	NBB-9	NBC-2

NERVE HOOKS  
NERVHAKEN

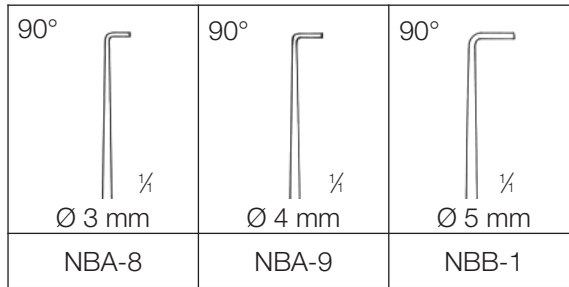

ALL MODELS ALSO  
AVAILABLE WITH  
CERAMO SURFACE

ALLE MODELLE AUCH  
MIT CERAMO-OBER-  
FLÄCHE ERHÄLTICH

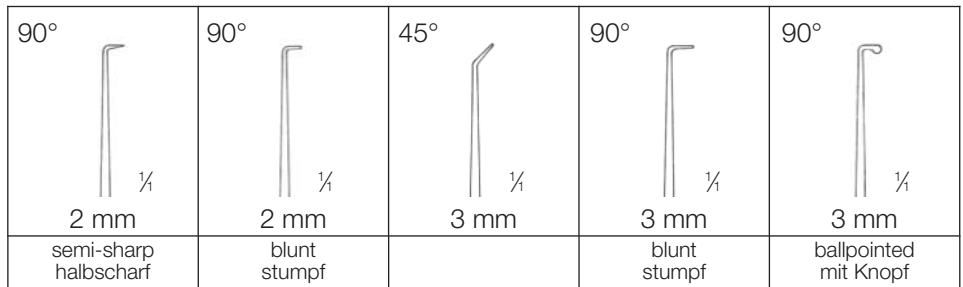









UP / AUF	NBH-8	NBH-9	NBJ-1	NBJ-5	NBJ-3
RIGHT / RECHTS	NBJ-7	NBJ-8	NBJ-9	NBK-6	NBK-4
LEFT / LINKS	NBK-1	NBK-2	NBK-3	NBL-1	NBK-8

CERAMO®



260 mm  
a = 120 mm

	0,5 mm	TOR-7
$\frac{1}{4}$ needle holder / Nadelhalter	1,0 mm	TOQ-1
	0,5 mm	TOR-8
$\frac{1}{4}$ needle holder / Nadelhalter	1,0 mm	TOQ-2
	2,0 mm	TOQ-3
$\frac{1}{4}$ spoon pliers / Löffelzange	4,0 mm	TOQ-4
	2,0 mm	TOQ-5
$\frac{1}{4}$ spoon pliers / Löffelzange		
	pointed spitz	TOR-1
$\frac{1}{4}$ scissors / Schere	blunt stumpf	TOR-3
	pointed spitz	TOR-2
$\frac{1}{4}$ scissors / Schere	blunt stumpf	TOR-4
	blunt stumpf	TOR-9
$\frac{1}{4}$ scissors / Schere	pointed spitz	TOR-0
	0,5 mm	TOR-5
$\frac{1}{4}$ forceps / Pinzette		
	0,5 mm	TOR-6
$\frac{1}{4}$ forceps / Pinzette		

ROTATABLE SHAFT  
DREHBARER SCHAFT





CERAMO®

FOR / FÜR YASARGIL  
+ SUGITA CLIPS



		CLIP ROTATABLE / DREHBAR	
		 1/3	
TOTAL LENGTH GESAMTLÄNGE		230 mm	270 mm
LENGTH a LÄNGE a		80 mm	120 mm
CLIP SIZE CLIP GRÖßE	MINI	TOQ-9	TOQ-7
	STANDARD	TOQ-8	TOQ-6

ROTATABLE SHAFT  
DREHBARER SCHAFT



MEMORY

FOR / FÜR YASARGIL + SUGITA CLIPS

		CLIP FIXED / STARR			CLIP ROTATABLE / DREHBAR		
		 1/3			 1/3		
LENGTH a LÄNGE a		70 mm	90 mm	110 mm	70 mm	90 mm	110 mm
CLIP SIZE CLIP GRÖßE	MINI	NIB-1	NIB-2	NIB-3	NIB-7	NIB-8	NIB-9
	STANDARD	NIC-0	NIC-1	NIB-0	NIB-4	NIB-5	NIB-6

MALLEABLE SHAFT / BIEGBARER SCHAFT

The shafts of MEMORY clip applying forceps are constructed of shape-memory metal. They are malleable in normal O.R. temperatures. Soft pressure allows "permanent" deformation of shape according to the surgeon's needs. However in higher temperatures, such as those found in the autoclave, the instruments regain their initial shape.

MEMORY Clipanlegezangen haben einen Schaft aus Formgedächtnismetall. Sie sind bei normaler OP-Temperatur biegsam. Sie können durch sanften Druck in die gewünschte Form gebracht werden. Unter höheren Temperaturen, wie bei der Sterilisation, nehmen sie ihre ursprüngliche Form wieder an.

CERAMO® NICOLA

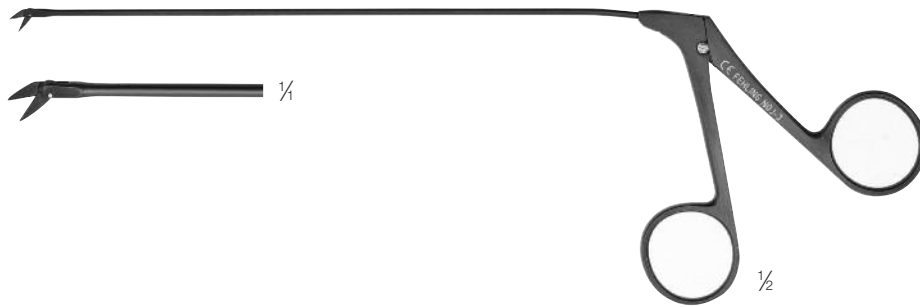

SCISSORS  
SCHEREN

	straight / gerade	up / aufwärts	down / abwärts	left / links	right / rechts
160 mm	NOJ-1	NOJ-2	NOJ-3	NOJ-4	NOJ-5
	NBR-9	-	-	-	-
200 mm	NTF-1	NTF-4	NTF-5	NTF-3	NTF-2
	TOM-6	-	-	TOM-8	TOM-7
	NBS-1	NBS-2	NBS-3	NBS-5	NBS-4
250 mm	NOL-7			NOL-8	NOL-9

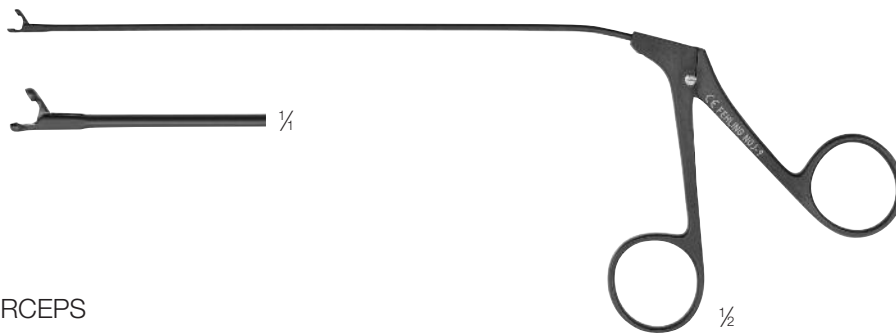

GRASPING FORCEPS  
FASSZANGEN

	straight / gerade	up / aufwärts	down / abwärts	left / links	right / rechts
160 mm	NOJ-6	NOJ-7	NOJ-8	NOJ-9	NOK-0
	NBR-3	-	-	-	-
180 mm	-	-	-	NOM-0	NOI-9
200 mm	NTF-6	NTF-7	NTF-8	NTF-9	NTG-0
	TOM-1	-	-	-	-
	NBR-4	NBR-5	NBR-6	NBR-8	NBR-7
250 mm	NOK-8	-	-	-	-

TITANIUM / TITAN

UNCOATED / UNBESCHICHTET

CERAMO®

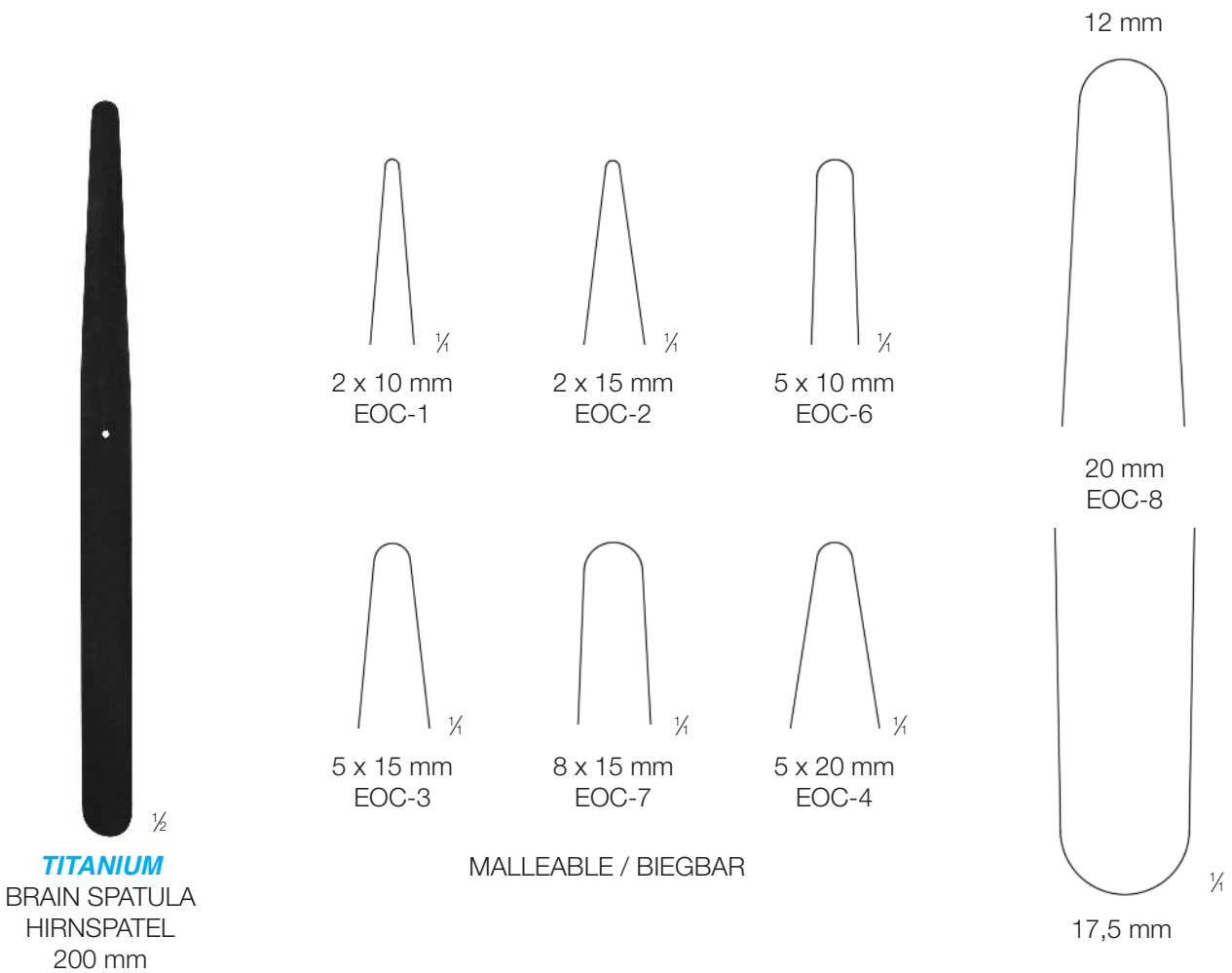
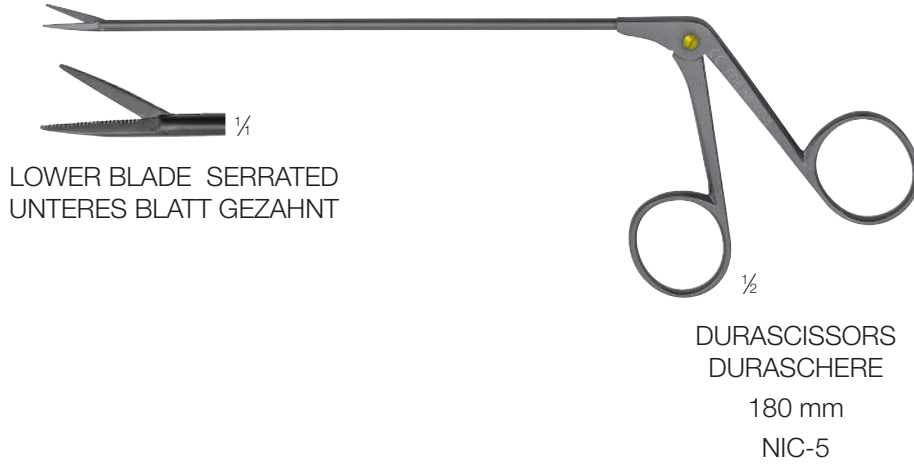

CERAMO® SUPERPLAST

BRAIN SPATULAS  
HIRNSPATEL

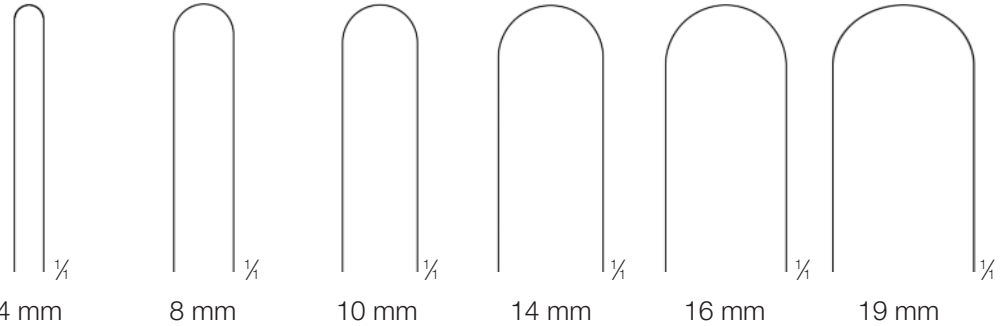

STANDARD	EOI-1	EOI-2	EOI-3	EOI-4	EOI-5	EOI-9
STRONG STARK	EOI-6	EOI-7	EOI-8	EOK-9	-	-

SUPERPLAST Instruments are constructed of shapememory metal. They are malleable in normal O.R. temperatures. Soft pressure allows "permanent" deformation of shape according to the surgeon's needs. However in higher temperatures, such as those found in the autoclave, the instruments regain their initial shape.

SUPERPLAST Instrumente sind aus Metall mit Formgedächtnis. Sie sind bei normaler OP-Temperatur biegsam. Sie können durch sanften Druck in die gewünschte Form gebracht werden. Unter höheren Temperaturen, wie bei der Sterilisation, nehmen sie ihre ursprüngliche Form wieder an.

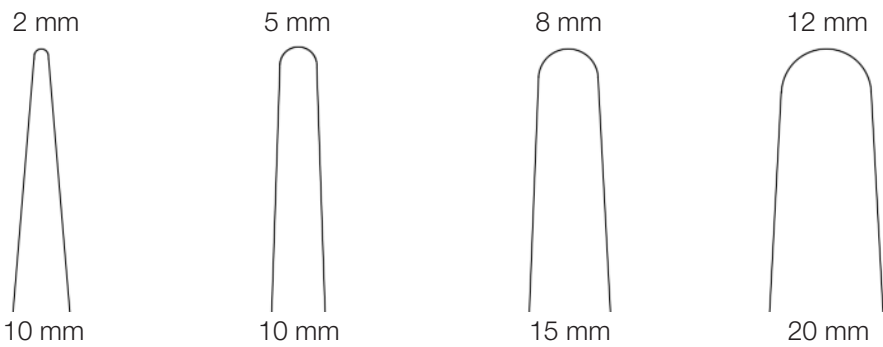

STANDARD	EOK-1	EOK-2	EOK-3	EOK-4
STRONG STARK	EOK-5	EOK-8	EOK-7	-

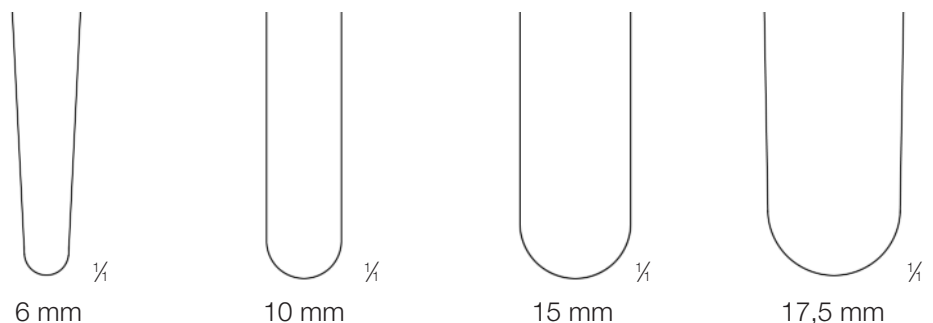

CERAMO® SUPERPLAST

BRAIN SPATULAS  
HIRNSPATEL

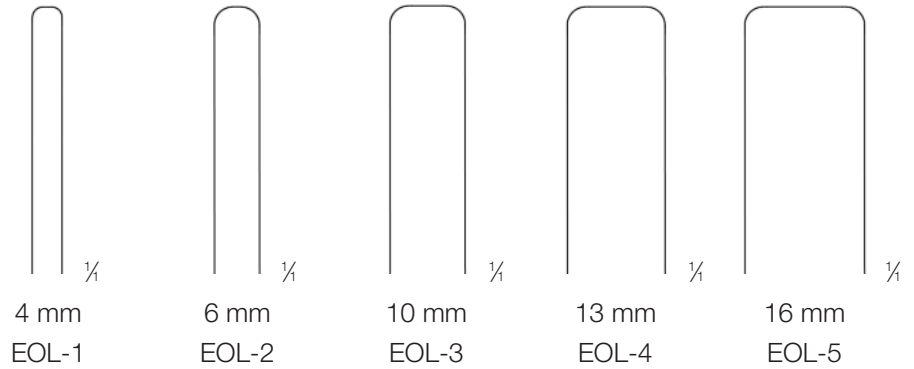
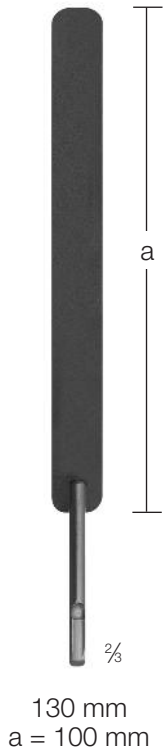

SUPERPLAST Instruments are constructed of shapememory metal. They are malleable in normal O.R. temperatures. Soft pressure allows "permanent" deformation of shape according to the surgeon's needs. However in higher temperatures, such as those found in the autoclave, the instruments regain their initial shape.

SUPERPLAST Instrumente sind aus Metall mit Formgedächtnis. Sie sind bei normaler OP-Temperatur biegsam. Sie können durch sanften Druck in die gewünschte Form gebracht werden. Unter höheren Temperaturen, wie bei der Sterilisation, nehmen sie ihre ursprüngliche Form wieder an.

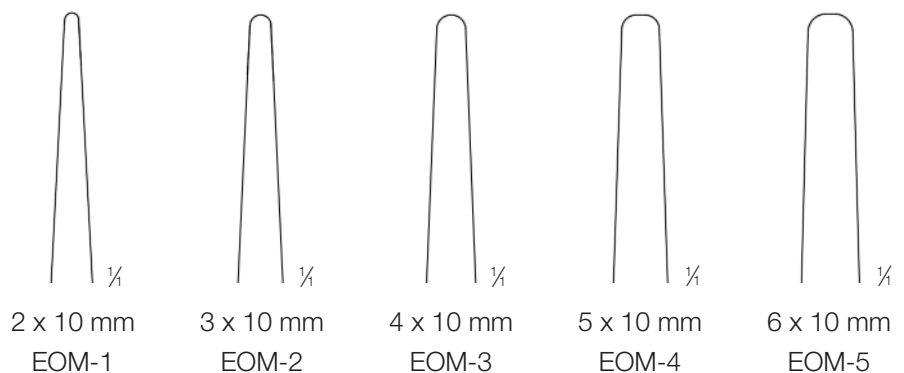

Shafts suitable for all common head rest systems.  
Die Schäfte passen in alle gängigen Kopfhaltssysteme.

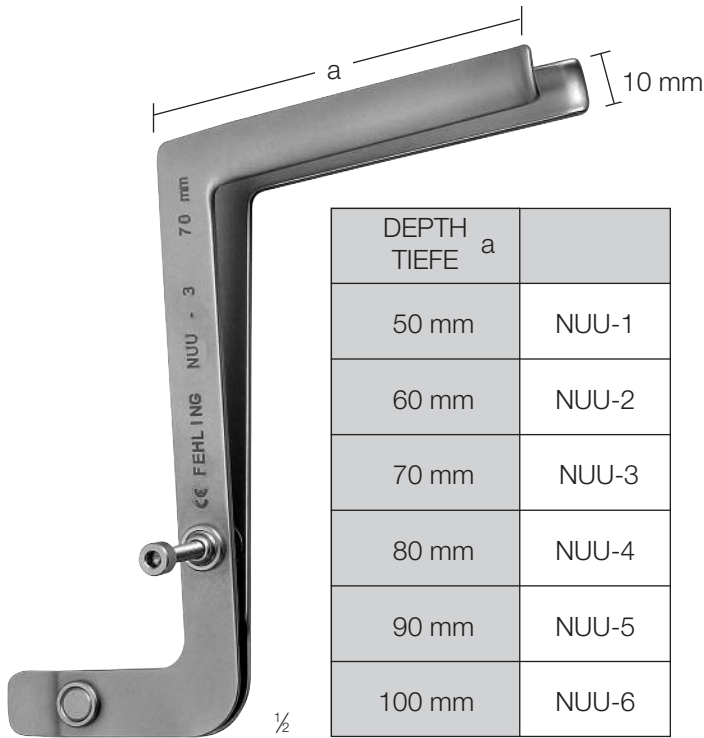

DEPTH TIEFE	a
50 mm	NUU-1
60 mm	NUU-2
70 mm	NUU-3
80 mm	NUU-4
90 mm	NUU-5
100 mm	NUU-6

PERNECZKY TITANIUM  
BRAIN RETRACTOR  
HIRNSPREIZER



SUPPORT FOR LEYLA-RETRACTOR  
SPATELHALTER FÜR LEYLA-RETRAKTOR

NEA-2



exemplary configuration  
Konfigurationsbeispiel

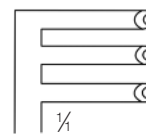

3 x 3 TEETH/ZÄHNE  
SEMI-SHARP  
HALBSCHARF

DIETZ  
160 mm  
ECP-5H



CERAMO®  
PITUITARY SPECULUM  
HYPOPHYSENSPEKULUM

70 x 12 mm	NVG-1V
	NVL-1V
80 x 12 mm	NVG-2V
	NVL-2V
90 x 12 mm	NVG-3V
	NVL-3V
100 x 12 mm	NVG-4V
	NVL-4V
110 x 12 mm	NVG-5V
	NVL-5V

TITANIUM / TITAN



HEXAGON WRENCH  
FOR SPECULUM  
SECHSKANTSCHLÜSSEL  
FÜR SPEKULUM

NVG-9



KILLIAN  
NASAL SPECULUM  
NASENSPEKULUM

with locking screw  
mit Stellschraube



KILLIAN  
NASAL SPECULUM  
NASENSPEKULUM

37 x 7 mm	OAT-9
52 x 7 mm	OAU-1
75 x 7 mm	OAU-2

36 x 7 mm	OAT-5
56 x 7 mm	OAT-6
75 x 7 mm	OAT-7
90 x 7 mm	OAT-8

CERAMO®

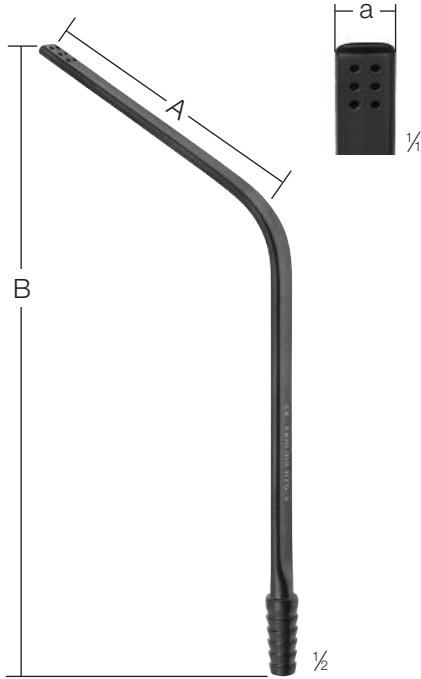

WIDTH BREITE a	LENGTH / LÄNGE A / B		
	70 / 155 mm	80 / 160 mm	90 / 165 mm
6 mm	NZQ-7	NZQ-8	NZQ-9
8 mm	NZQ-3	NZQ-4	NZQ-5

SCHROEDER  
SUCTION SPATULA  
SAUGSPATEL

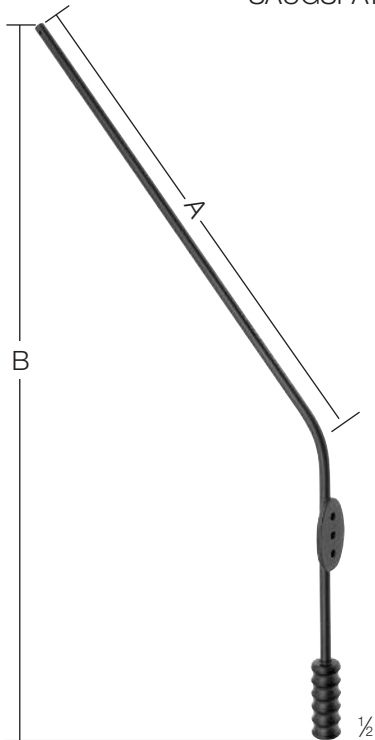

Ø TUBE ROHR	LENGTH / LÄNGE A / B	
	130 / 180 mm	170 / 210 mm
1,5 mm	HAV-5	HAV-6
2,5 mm	HAV-1	HAV-2
3,0 mm	HAV-3	HAV-4

SCHICK  
MICRO SUCTION TUBE  
MIKROSAUGER